

DESCRIPTION:
SNAPNRACK, ULTRA RAIL COMP KIT

PART NUMBER(S):
SEE BELOW

DRAWN BY:
 mwatkins

REVISION:
B

SnapNrack™
 Solar Mounting Solutions

595 MARKET STREET, 29TH FLOOR • SAN FRANCISCO, CA 94105 USA
 PHONE (415) 580-6900 • FAX (415) 580-6902

THE INFORMATION IN THIS DRAWING IS CONFIDENTIAL AND PROPRIETARY. ANY REPRODUCTION, DISCLOSURE, OR USE THEREOF IS PROHIBITED WITHOUT THE WRITTEN CONSENT OF SUNRUN SOUTH LLC.

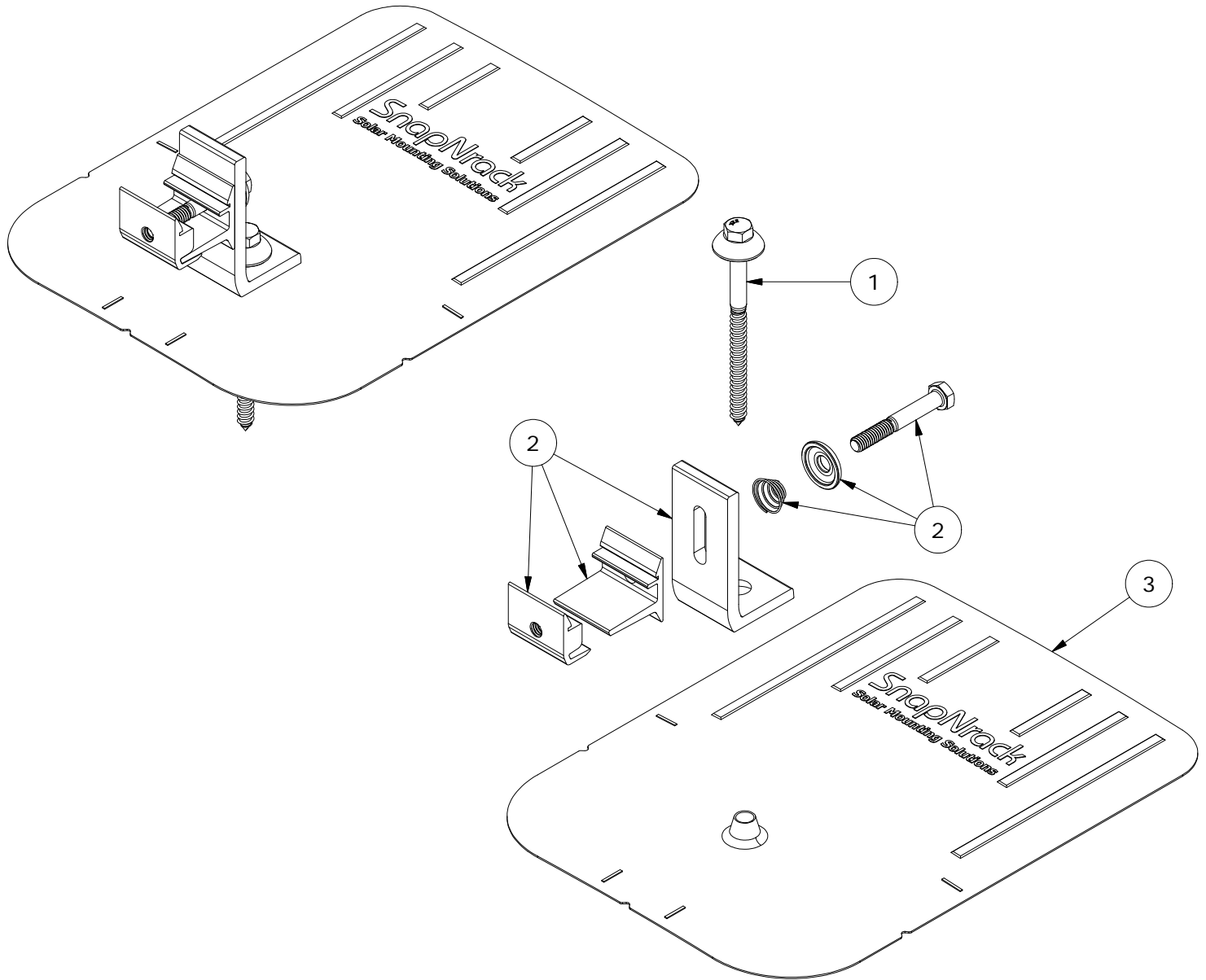

PARTS LIST			
ITEM	QTY	PART NUMBER	DESCRIPTION
1	1	242-92266	SNAPNRACK, UMBRELLA LAG, TYPE 3, 4IN, SS
2	1	242-01219, 242-01220	SNAPNRACK, ULTRA FOOT FOR U FLASHING, SILVER / BLACK
3	1	232-01375, 232-01376	SNAPNRACK, COMP FLASHING, 9IN X 12IN, SILVER / BLACK ALUM

MATERIALS:	6000 SERIES ALUMINUM, STAINLESS STEEL, RUBBER
DESIGN LOAD (LBS):	405 UP, 788 DOWN, 236 SIDE
ULTIMATE LOAD (LBS):	2006 UP, 4000 DOWN, 1070 SIDE
TORQUE SPECIFICATION:	12 LB-FT
CERTIFICATION:	UL 2703, FILE E359313; WIND-DRIVEN RAIN TEST FROM UL SUBJECT 2582
WEIGHT (LBS):	0.80

DESCRIPTION:

SNAPNRACK, ULTRA RAIL COMP KIT

DRAWN BY:

mwatkins

SnapNrack™
Solar Mounting Solutions

PART NUMBER(S):

SEE BELOW

REVISION:

B

595 MARKET STREET, 29TH FLOOR • SAN FRANCISCO, CA 94105 USA
PHONE (415) 580-6900 • FAX (415) 580-6902

THE INFORMATION IN THIS DRAWING IS CONFIDENTIAL AND PROPRIETARY. ANY REPRODUCTION, DISCLOSURE, OR USE THEREOF IS PROHIBITED WITHOUT THE WRITTEN CONSENT OF SUNRUN SOUTH LLC.

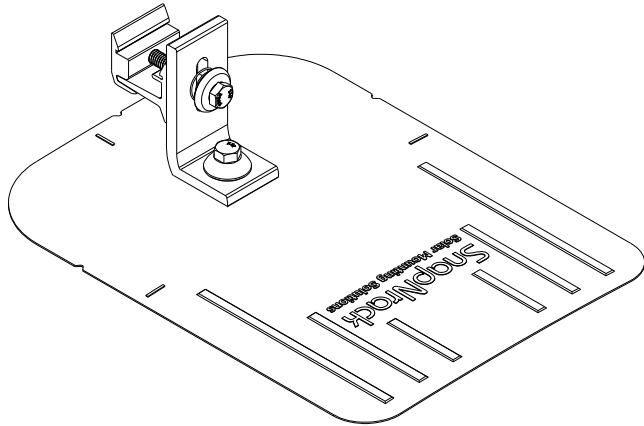

UMBRELLA L FOOT PROPERTIES

SKU	DESCRIPTION
242-01219	ULTRA RAIL UMBRELLA L FOOT, SILVER
242-01220	ULTRA RAIL UMBRELLA L FOOT, BLACK

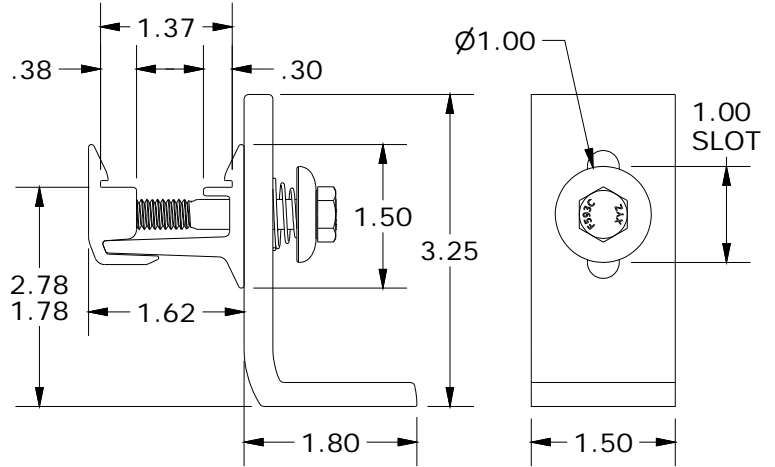

COMP FLASHING PROPERTIES

SKU	DESCRIPTION
232-01375	COMP FLASHING, 9" X 12", BLACK ALUM
232-01376	COMP FLASHING, 9" X 12", SILVER ALUM

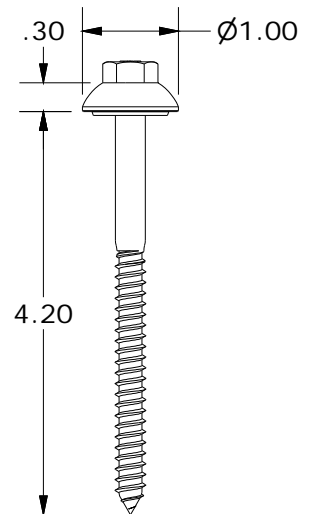
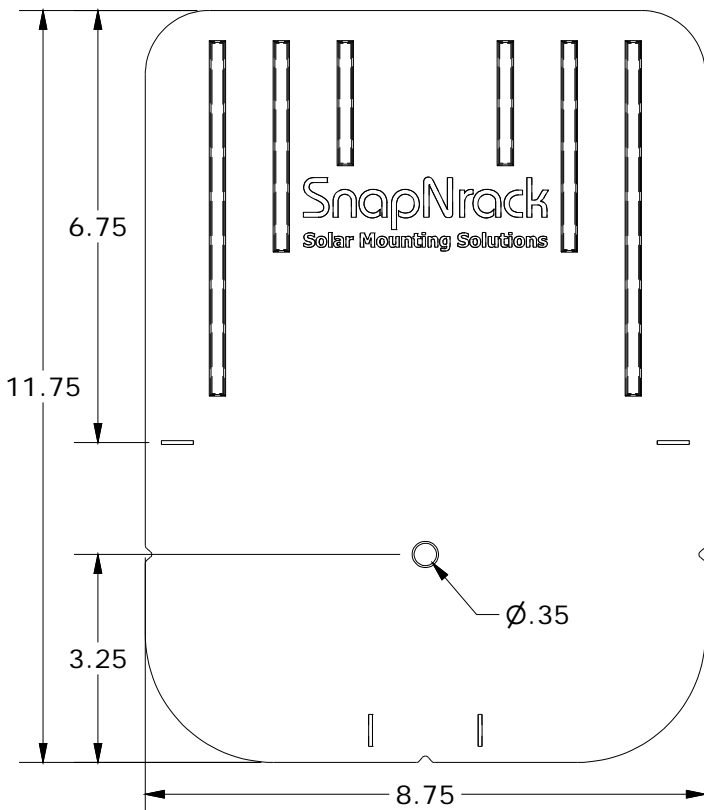

ALL DIMENSIONS IN INCHES